

应用于广阔领域, 销售量大的大型通用型。

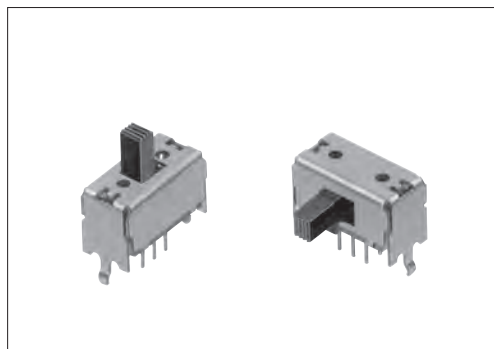

## ■主要规格



项目		规格
最大额定/最小额定 (电阻负载)		0.1A 30V DC / 50 $\mu$ A 3V DC
接触电阻 (初期/寿命后)		25m $\Omega$ max. / 65m $\Omega$ max.
动作力		参阅外形图
操作寿命	无负载	10,000 cycles
	负载	10,000 cycles (0.1A 30V DC)

## ■产品一览

行程 (mm)	操作部方向	操作部长度 (mm)	电路数	接点数	安装方法	切换时限	焊接方法	最小订货单位 (pcs.)		产品编号	图号
								日本	出口		
2	Vertical	6	1	2	Snap-in (t1.6)	Non shorting	Manual, Dip	800	4,000	SSSF011700	1
		9		3						SSSF012100	
		6	2	2						SSSF014800	2
		9		3						SSSF021500	
		6		SSSF021900							
		9		SSSF024800							
		6	4	2						SSSF025100	4
		9		3						SSSF040800	
	Horizontal	6	1	2				600	3,000	SSSF111800	6
		9		3						SSSF112500	
		6	2	2						SSSF114900	7
		9		3						SSSF115300	
		6		2						SSSF121900	
		9		3						SSSF122400	
		6	4	2						SSSF125300	9
		9		3						SSSF125800	
6	4	2	800	4,000	SSSF141000	10					
9		3			SSSF141300						

## ■包装规格

散装

产品编号	包装数 (pcs.)		出口包装箱尺寸 (mm)
	1箱/日本	1箱/出口包装	
SSSF011700, SSSF012100 SSSF014800, SSSF021500 SSSF021900, SSSF024800 SSSF025100, SSSF040800 SSSF112500, SSSF115300 SSSF122400, SSSF125800 SSSF141000, SSSF141300	800	4,000	400×270×290
SSSF111800, SSSF114900 SSSF121900, SSSF125300	600	3,000	

外形图

操作部上出型

Unit:mm

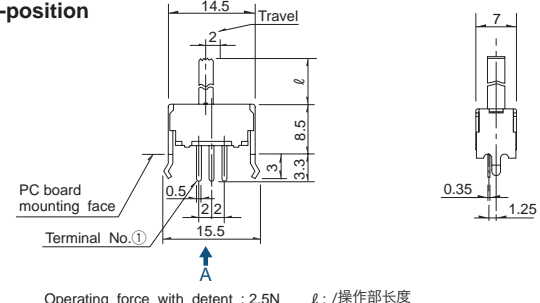
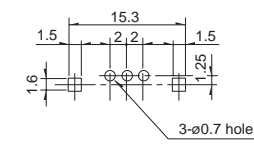
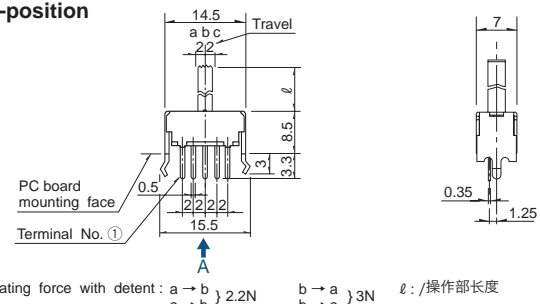
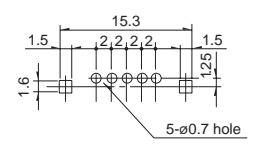
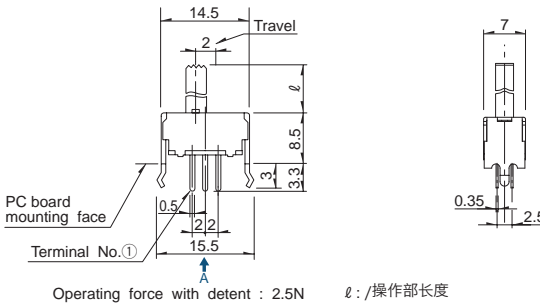
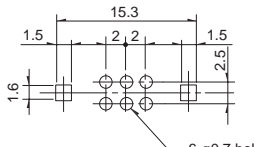
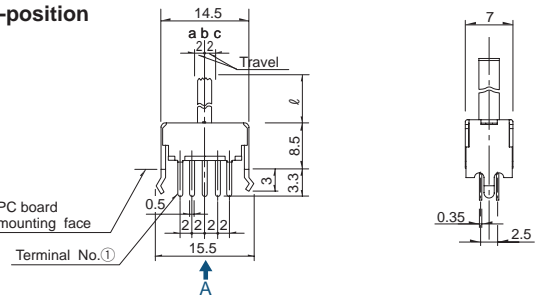
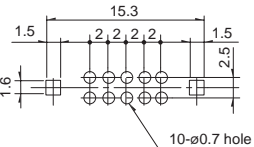
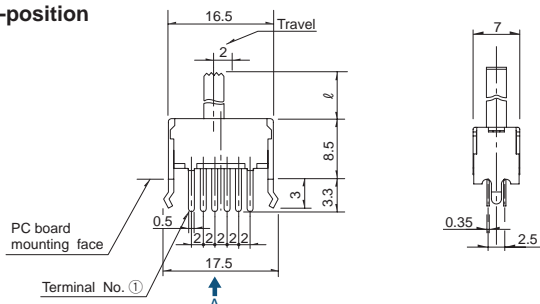
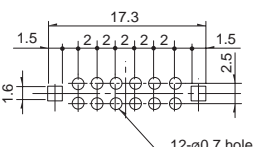
No.	形状	印刷电路板安装孔尺寸图 (自A方向看)
1	<p><b>1-pole, 2-position</b></p>  <p>Operating force with detent : 2.5N <math>l</math> : /操作部长度</p>	 <p>3-<math>\phi</math>0.7 hole</p>
2	<p><b>1-pole, 3-position</b></p>  <p>Operating force with detent : <math>\begin{matrix} a \rightarrow b \\ c \rightarrow b \end{matrix} \} 2.2\text{N}</math> <math>\begin{matrix} b \rightarrow a \\ b \rightarrow c \end{matrix} \} 3\text{N}</math> <math>l</math> : /操作部长度</p>	 <p>5-<math>\phi</math>0.7 hole</p>
3	<p><b>2-pole, 2-position</b></p>  <p>Operating force with detent : 2.5N <math>l</math> : /操作部长度</p>	 <p>6-<math>\phi</math>0.7 hole</p>
4	<p><b>2-pole, 3-position</b></p>  <p>Operating force with detent : <math>\begin{matrix} a \rightarrow b \\ c \rightarrow b \end{matrix} \} 2.2\text{N}</math> <math>\begin{matrix} b \rightarrow a \\ b \rightarrow c \end{matrix} \} 3\text{N}</math> <math>l</math> : /操作部长度</p>	 <p>10-<math>\phi</math>0.7 hole</p>
5	<p><b>4-pole, 2-position</b></p>  <p>Operating force with detent : 2.5N <math>l</math> : /操作部长度</p>	 <p>12-<math>\phi</math>0.7 hole</p>

检测

滑动

按动

旋转

电源

切换式

小型通用

大型通用

检测

滑动

按动

旋转

电源

切换式

小型通用

大型通用

外形图

操作部侧外型

Unit:mm

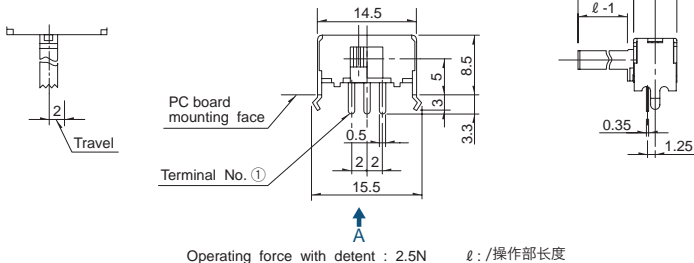
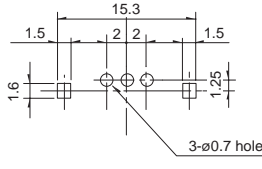
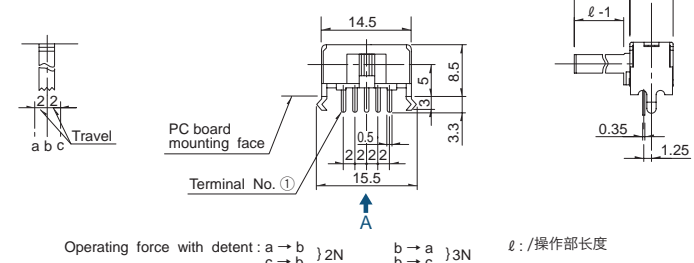
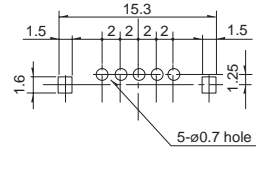
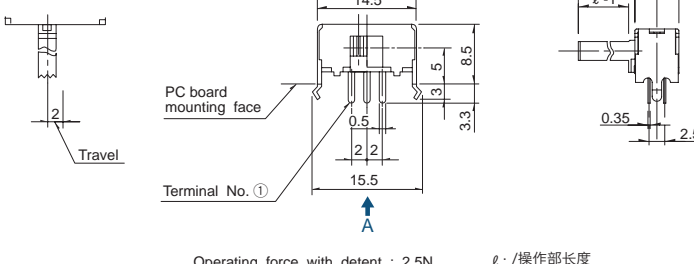
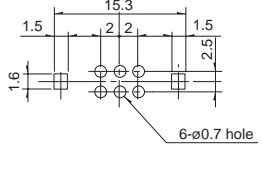
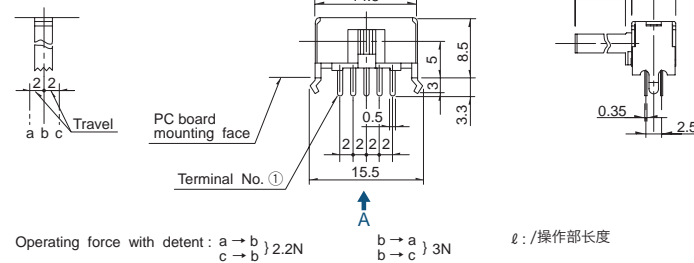
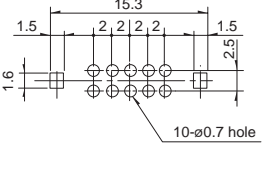
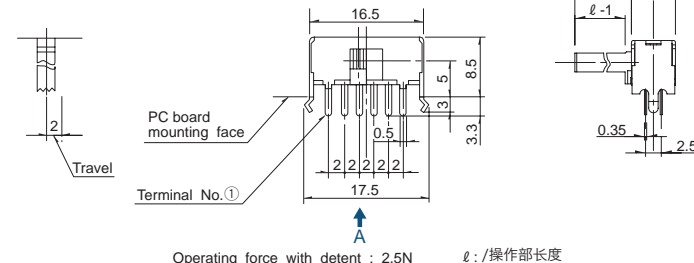
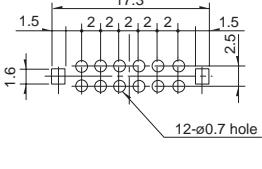
No.	形状	印刷电路板安装孔尺寸图 (自A方向看)
6	<p><b>1-pole, 2-position</b></p>  <p>Operating force with detent : 2.5N    <math>l</math> : /操作部长度</p>	 <p>3-<math>\phi</math>0.7 hole</p>
7	<p><b>1-pole, 3-position</b></p>  <p>Operating force with detent : a <math>\rightarrow</math> b } 2N    b <math>\rightarrow</math> a } 3N c <math>\rightarrow</math> b } 2N    b <math>\rightarrow</math> c } 3N    <math>l</math> : /操作部长度</p>	 <p>5-<math>\phi</math>0.7 hole</p>
8	<p><b>2-pole, 2-position</b></p>  <p>Operating force with detent : 2.5N    <math>l</math> : /操作部长度</p>	 <p>6-<math>\phi</math>0.7 hole</p>
9	<p><b>2-pole, 3-position</b></p>  <p>Operating force with detent : a <math>\rightarrow</math> b } 2.2N    b <math>\rightarrow</math> a } 3N c <math>\rightarrow</math> b } 2.2N    b <math>\rightarrow</math> c } 3N    <math>l</math> : /操作部长度</p>	 <p>10-<math>\phi</math>0.7 hole</p>
10	<p><b>4-pole, 2-position</b></p>  <p>Operating force with detent : 2.5N    <math>l</math> : /操作部长度</p>	 <p>12-<math>\phi</math>0.7 hole</p>

■ 电路图 (自A方向看)

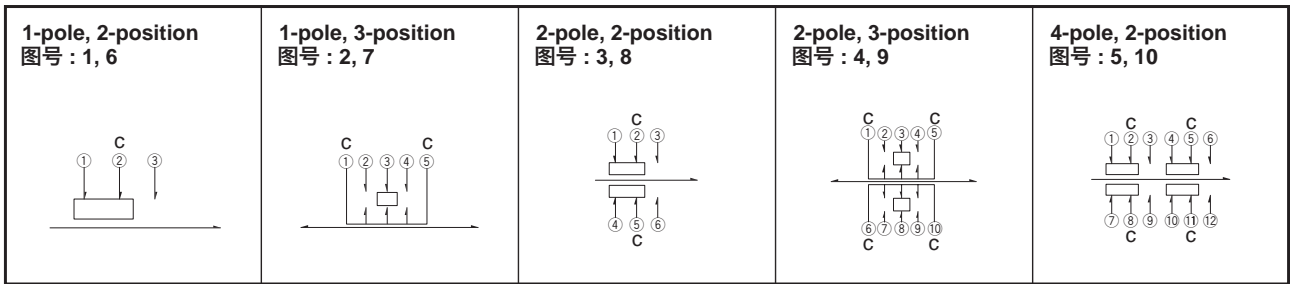

■ 操作部形状

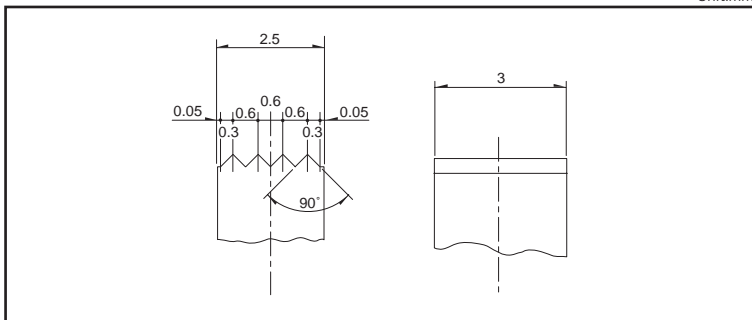

■ 框架脚形状

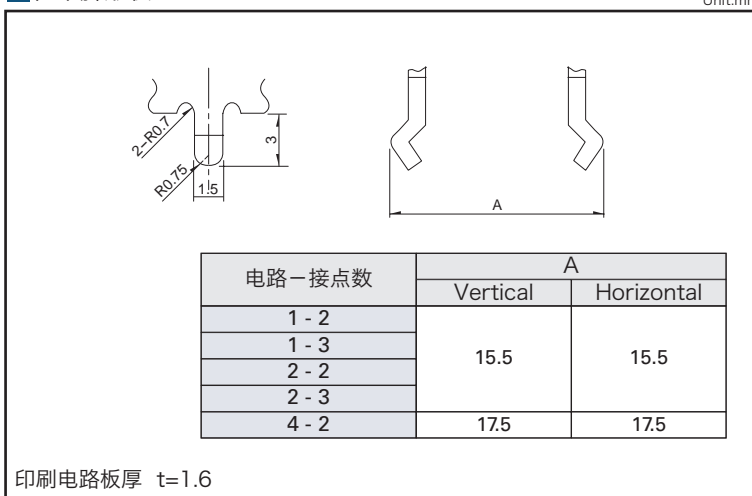

检测

滑动

按动









旋转

电源

切换式

小型通用

大型通用

系列		SSSS2※	SSSS9	SSAC	SSSF	SSSU
照片						
操作部方向	Horizontal	●	●	●	●	●
	Vertical	●	●	—	●	●
电路接点数	1-2	●	●	—	●	●
	1-3	●	●	—	●	●
	1-4	●	—	—	—	—
	2-2	●	●	●	●	●
	2-3	●	●	●	●	●
	2-4	●	—	—	—	—
	4-2	—	—	—	●	●
行程 (mm)		2	2	1.5	2	3
使用温度范围		- 40°C to + 85°C		- 10°C to + 60°C	- 40°C to + 85°C	
车用产品		—	—	—	—	—
生命周期						
最大额定 (电阻负载)		0.3A 6V DC	0.1A 12V DC	1mA 5V DC	0.1A 30V DC	
最小额定 (电阻负载)		50μA 3V DC	1mA 5V DC	50μA 3V DC		
耐久性	无负载寿命	10,000 cycles 100mΩ max. ※	10,000 cycles 60mΩ max.	10,000 cycles 200mΩ max.	10,000 cycles 45mΩ max.	
	负载寿命 最大额定负载	10,000 cycles 130mΩ max. ※	10,000 cycles 80mΩ max.		10,000 cycles 65mΩ max.	
电性能	初期接触电阻	70mΩ max.	30mΩ max.	100mΩ max.	25mΩ max.	
	绝缘电阻	100MΩ min. 500V DC		100MΩ min. 100V DC	100MΩ min. 500V DC	
	耐电压	500V AC for 1minute		100V AC for 1minute	500V AC for 1minute	
机械性能	端子强度		3N for 1minute		5N for 1minute	
	操作部 强度	工作 方向	20N	30N	5N	30N
		拉引 方向	10N			
耐环境 性能	耐寒性能	- 20°C 500h	- 40°C 500h	- 20°C 96h	- 40°C 500h	
	耐热性能	85°C 500h		85°C 96h	85°C 500h	
	耐湿性能	60°C, 90 to 95%RH 500h		40°C, 90 to 95%RH 96h	60°C, 90 to 95%RH 500h	
页		85	90	96	98	102

滑动开关焊接条件 . . . . .	106
滑动开关使用时的注意事项 . . . . .	107

## 注

- ※ SSSS213202 的使用寿命为 100 cycles。
- 表中的 ● 符号表示适用于系列内的全部产品。

## 回流方式的参考举例

1. 加热方式 为远红外线加热的上下加热方式。
2. 温度测量方式用  $\phi 0.1 \sim \phi 0.2$ 的CA (K) 或CC (T) 测量。位置在焊接连接部 (铜箔面) 测量。固定方式采用耐热胶带。
3. 温度分布

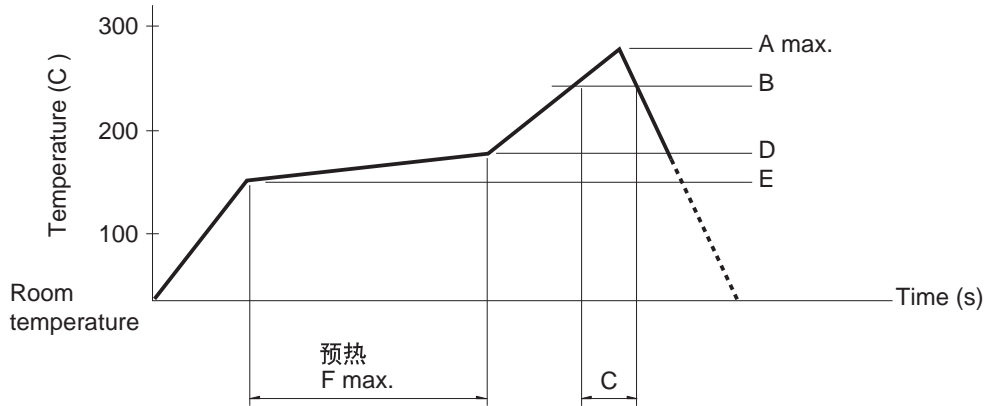

系列 (回流型)		A (°C) 3s max.	B (°C)	C (s)	D (°C)	E (°C)	F (s)
SSSS2	Vertical 1-pole, 3-position	260	230	40	180	150	120
	Horizontal 1-pole, 2-position 1-pole, 3-position 2-pole, 3-position						
	Vertical 1-pole, 2-position	250					
SSAG, SSAJ, SSAL, SSSS8, SSS7		260					

### 注

1. 上述条件, 为印刷电路板的零部件贴装面上的温度, 根据电路板的材质, 大小, 厚度等, 电路板温度和开关表面温度会有很大的不同, 关于开关表面温度, 也请在上述条件内使用。
2. 根据回流槽的种类, 条件稍有不同, 请事先充分进行确认之后使用。

## 手工焊接方式的参考举例

系列	焊接温度	焊接时间
SSSF, SSSU	350±10°C	3+1/0s
SSSS2	350±10°C	4s max.
SSSS9	350±10°C	3s max.
SSAG, SSAJ, SSAL	350±5°C	3s max.
SSSS8	330±5°C	3s max.
SSSS7	320±5°C	3s max.
SSAC	300±10°C	2s max.

## 浸焊方式的参考举例

适用于 For PC board 端子型

系列	项目		浸焊	
	预热温度	预热温度时间	焊接温度	焊接浸渍时间
SSSS2	100°C max.	60s max.	260±5°C	3±1s
SSSS9	120°C max.	60s max.	260±5°C	5+0/-1s (2 time)
SSSF, SSSU	100°C max.	60s max.	260±5°C	10±1s/5±1s
SSAC	100°C max.	60s max.	260±5°C	5±1s